

BAG GRAB IT

GROCERY BAG HOLDER



LEARNING TO SEW PROJECT 3

TERMS OF USE: you may use this pattern to make items to sell in quantities less than 100 per year. This pattern is not to be shared, sold, duplicated or transferred to another in any way. If you are purchasing this pattern to teach sewing, each student must purchase their own copy.

DESCRIPTION-The Bag Grab It is an easy to sew bag for holding plastic shopping bags.

RECOMMENDED FABRICS: WOVENS

Cotton, Linen, Broadcloth, Twill, Poplin, and Denim.

45" WIDE FABRIC REQUIREMENTS -YARDS:

Bag: A Fat Quarter (18" x 22") or a half yard of fabric (A half yard of fabric will make two bags.)

Notions:

Elastic One quarter yard of 1/2" wide elastic One half yard of 1/2" wide elastic if adding elastic to the top (optional)

One yard 1" wide ribbon

PRINTING INSTRUCTIONS

Be sure to set your printer to not scale the pattern pieces by selecting "Actual Size" or "Custom Scale: 100%" in your print dialog.

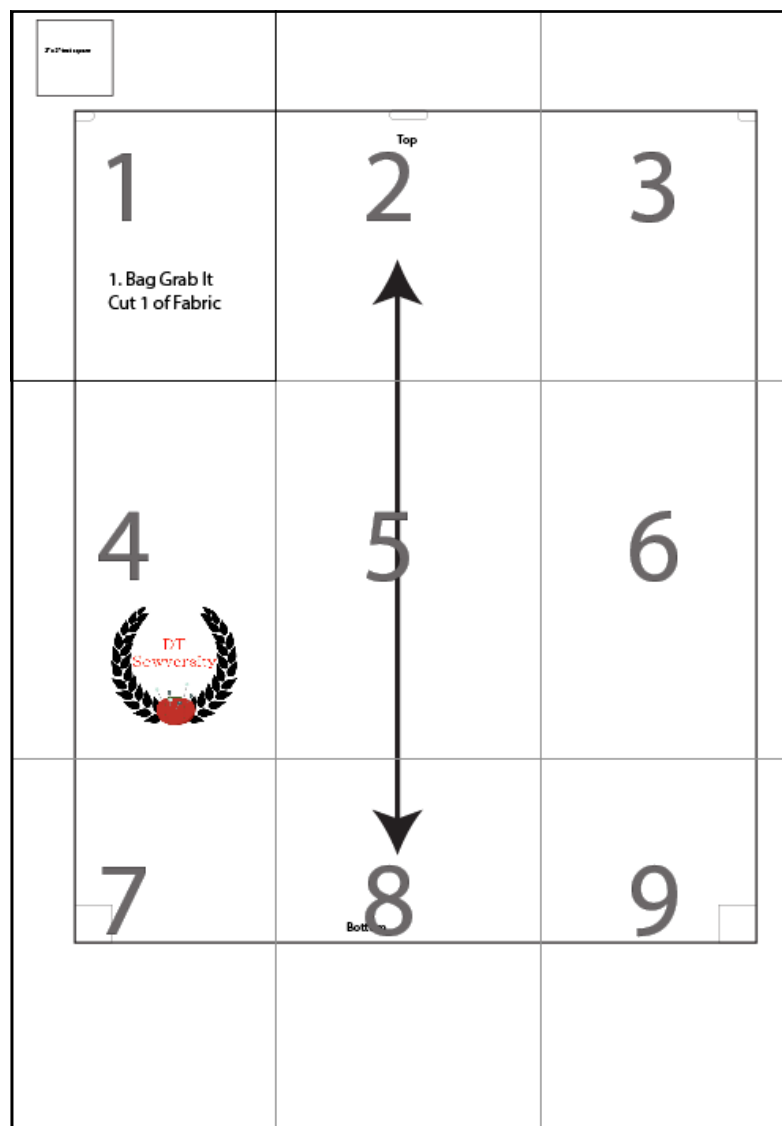

Pattern Assembly. Print the pages and align the dashed page borders so that they touch. Tape the pages in place.

FABRIC LAYOUT: If you are using a fat quarter, you may disregard the fabric layout, but do transfer the pattern markings. If you are using 45" wide fabric, you will be cutting two bags at once.

SELVAGES

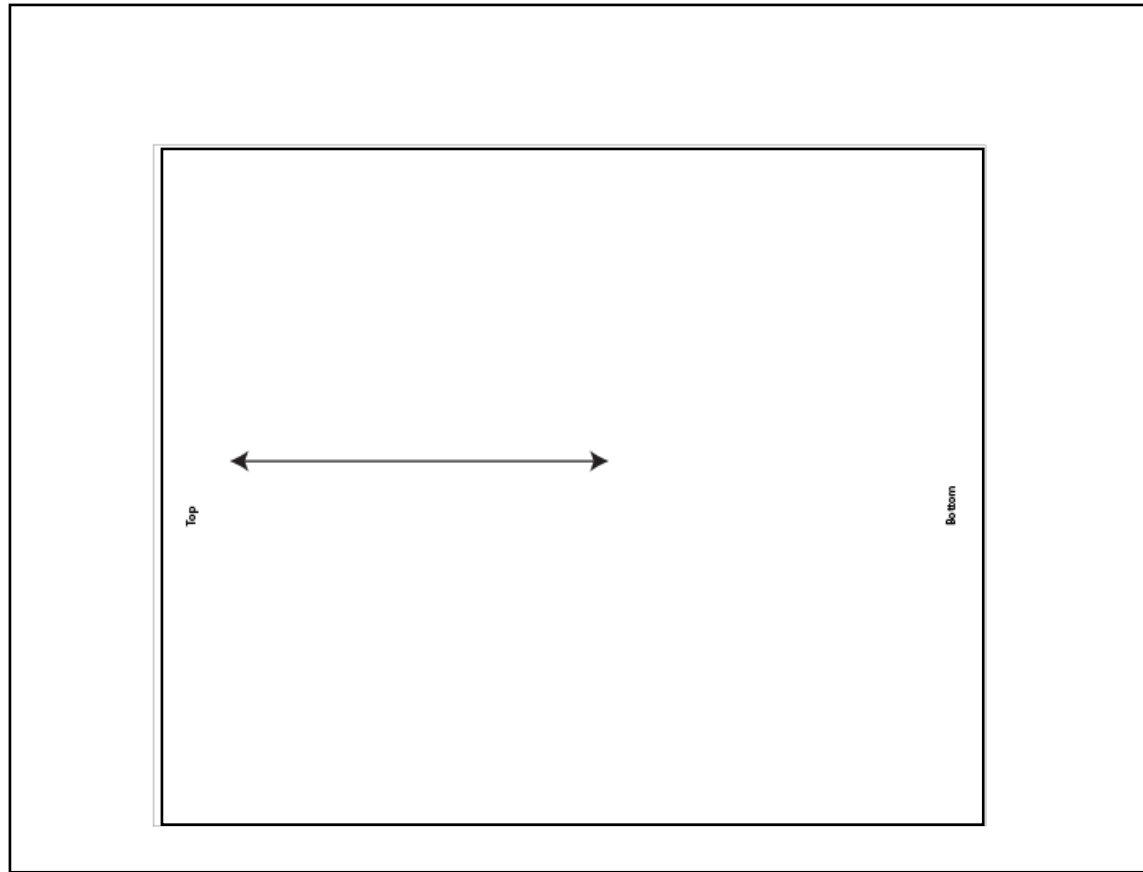

FOLD

READ THE INSTRUCTIONS AND TRANSFER ALL MARKINGS BEFORE BEGINNING TO SEW.
All seam allowances are included and are 1/2" unless specifically stated otherwise.

A casing is a "tunnel" through which elastic or a drawstring can be pulled.



Right Side

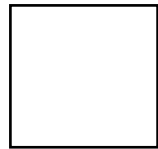

Wrong Side

1. Right sides together, Fold the bag in half lengthwise. Sew the long, open edge closed. Press the seam open and finish the edges.

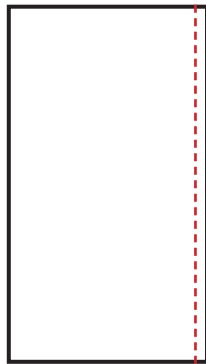

2. Fold the ribbon in half lengthwise and cut so that you have two pieces.

3. Fold each piece of the ribbon in half lengthwise. These will be your loops for hanging. Align the cut edge of the ribbon so that one side is on top of the other. Working on the wrong side, sew the loops to the top of the bag as marked.

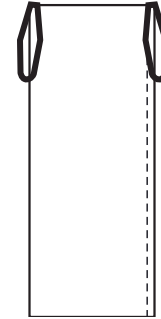

4. Turn the top edge down 1/4" toward the wrong side and press. Turn the edge down another 3/4" and press. Sew all across the top as close to the folded edge as possible. (If you want elastic in the top, leave a 2" opening for inserting the elastic. See step 7 for further information).

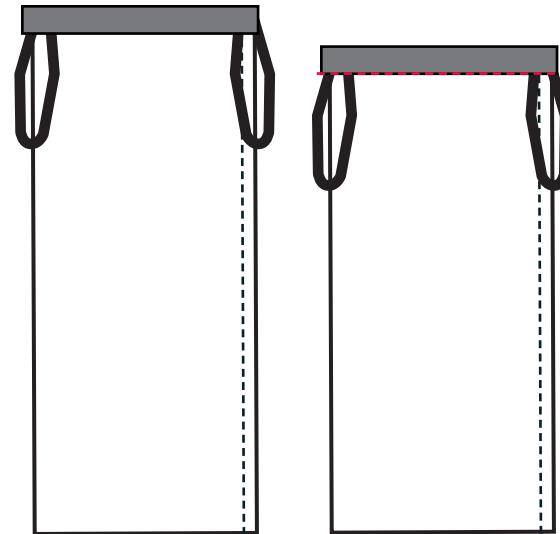

5. Bring the loops up and stitch in place at the top of the bag. If you are going to insert elastic at the top, be careful to just catch the top edge of the bag when sewing the loop. It may be easier to sew the loops in place with the bag right side out

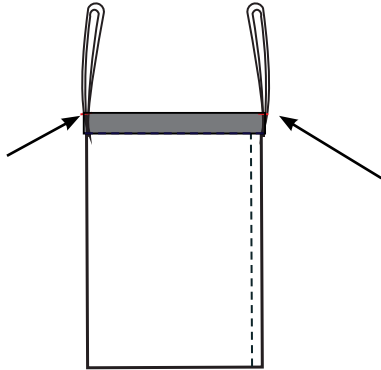

6. Turn the bottom edge 1/4" toward the wrong side and press. Fold another 3/4" and press again.

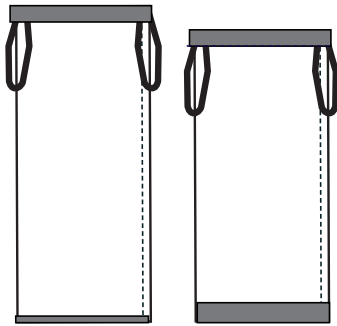

7. Sew the casing in place as close to the pressed edge as possible leaving it open between the markings.

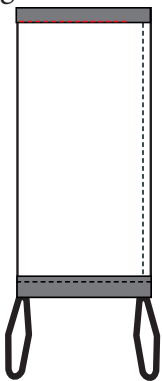

8. Attach a safety pin to one end of the elastic. Pull the elastic through the opening in the casing until the safety pin comes out the other side. Be sure to leave 2"-3" of elastic hanging out of the other end.

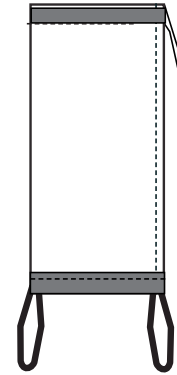

9. Check to make sure the elastic is not twisted. Remove the safety pin and overlap the ends of the elastic by 1/2" and pin together.

10. With the ends overlapped, sew a box stitch. To sew a box stitch, you can first baste your elastic in place to hold it. Stitch on top of the elastic in a square. You want the edge of your square as close to the cut edge as possible without going beyond it.



11. NEXT, SEW DIAGONALLY FROM CORNER TO CORNER MAKING AN "X".



12. Push the elastic into the casing. Sew the opening closed.

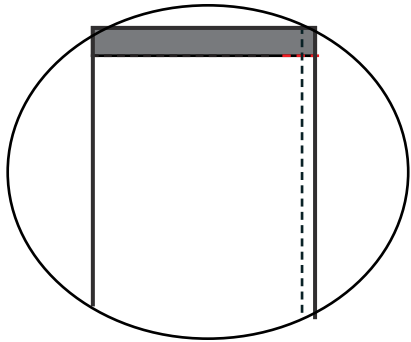

2" x 2" test square

1

1. Bag Grab It
Cut 1 of Fabric



Top

2



3

4



5

6

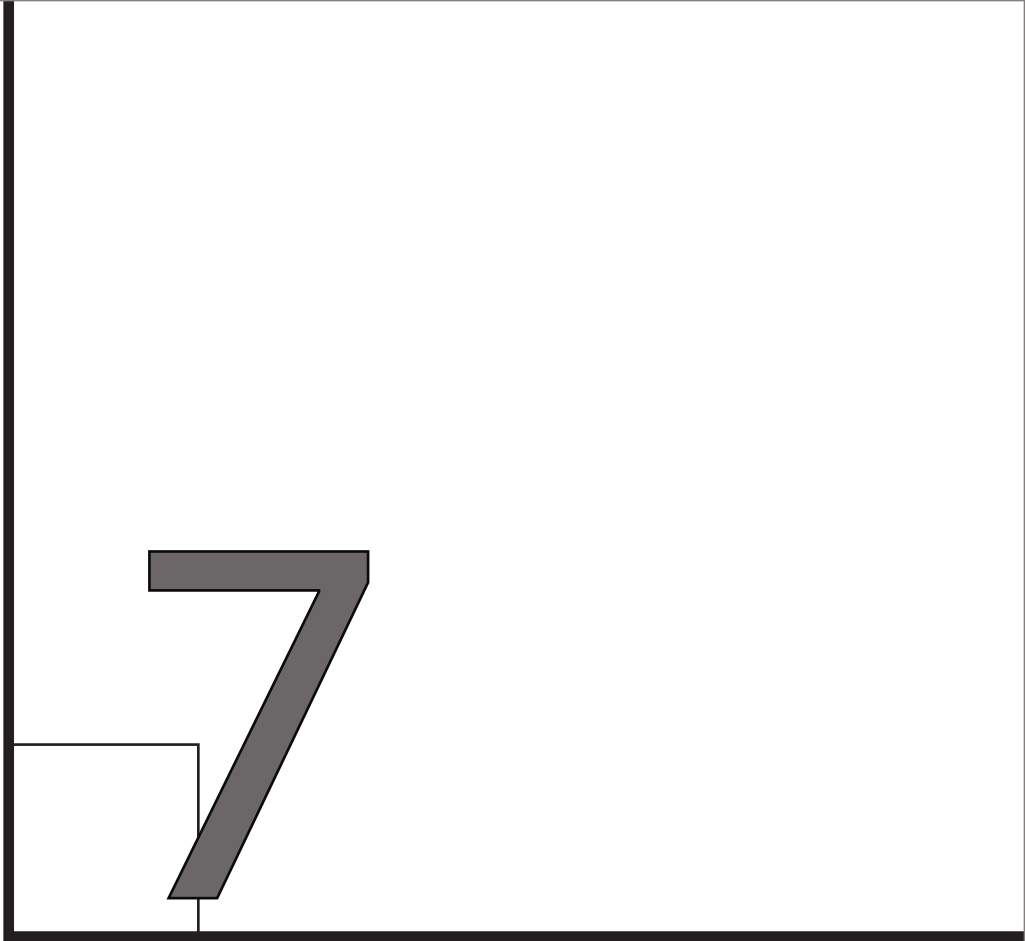

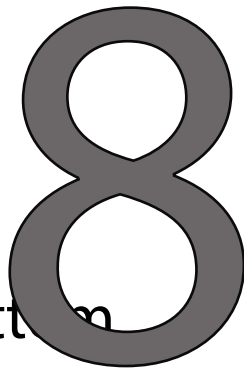

Bottom

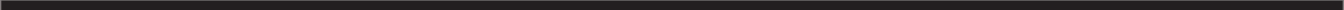

9

